

# ACRO Engineering Inc.

## Industrial DIN Rail Mounting Power Supply



Innovation . Fidelity . Initiative .



URL: <http://www.acro-powers.com>  
<http://www.acro-powers.com.tw>

## Features of Products

- ☑ Universal input range
- ☑ Short circuit protection
- ☑ Over voltage protection
- ☑ 3 years warranty
- ☑ Convection cooling
- ☑ RoHS compliance
- ☑ Over temperature protection
- ☑ Over circuit protection
- ☑ Overload protection
- ☑ High power density and great reliability
- ☑ DIN Rail / Wall bracket mounting solution
- ☑ Optional alarm signal / Redundant function

## Model Description

AD 1 072 C - 24 F R

Model Family	AD - DIN Rail	
Number of Output	1 - Single S - Single 2 - Dual	
Rated Output Wattage	072 - 72W	
Function	Blank - Power Supply C - Battery Charger M - DC Motor Power Supply	
Rated Output Voltage	24 - 24VDC	
Input Voltage Range	F - Full Range(100~240VAC) S - Selectable(115/230VAC) C - Full range with Active PFC	
Other function descriptions	S - Plastic housing R - Redundant and Rdy Function Alarm signal(for Battery Charger) C - Convection Cooling	

## Redundant and Rdy Function

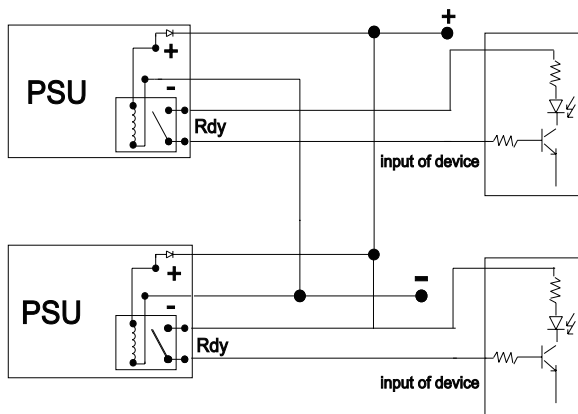

**Note :**  
Please adjust output voltage of each unit as close as possible to balance the loading.

# DIN Rail Power Supply

## AD1024F Series



**\*Convection Cooling**

Dimension:75.5(D)x45(W)x96(H)mm Package: 75pcs/ctn

20~24W Single Output

Input: 100~240VAC 47~63Hz

Model	Output	Redundant	Standard	MOQ	Datasheet
AD1020-05F	5VDC 4.0A	None	CE, UL	None	
AD1024-12F	12VDC 2.0A	None	CE, UL	None	
AD1024-24F	24VDC 1.0A	None	CE, UL	None	

## ADS024F(T/E) Series



T Version

E Version

**\*Convection Cooling**

Dimension:100(D)x36.5(W)x107(H)mm Package: 72pcs/ctn

24W Single Output

Input: 100~240VAC 47~63Hz

Model	Output	Redundant	Standard	MOQ(T/E)	Datasheet
ADS024-12F(T/E)	12VDC 2.0A	None	CE	None / 300	
ADS024-24F(T/E)	24VDC 1.0A	None	CE	None / 300	

## AD1048FS Series



**\*Convection Cooling**

Dimension:75.5(D)x45(W)x96(H)mm Package: 75pcs/ctn

48W Single Output

Input: 100~240VAC 47~63Hz

Model	Output	Redundant	Standard	MOQ	Datasheet
AD1048-12FS	12VDC 4.0A	None	CE, UL	None	
AD1048-15FS	15VDC 3.0A	None	CE, UL	None	
AD1048-24FS	24VDC 2.0A	None	CE, UL	None	
AD1048-48FS	48VDC 1.0A	None	CE	None	

## ADS048F(T/E) Series



T Version

E Version

**\*Convection Cooling**

Dimension:100(D)x36.5(W)x107(H)mm Package: 72pcs/ctn

48W Single Output

Input: 100~240VAC 47~63Hz

Model	Output	Redundant	Standard	MOQ(T/E)	Datasheet
ADS048-12F(T/E)	12VDC 4.0A	None	CE	None / 300	
ADS048-24F(T/E)	24VDC 2.0A	None	CE	None / 300	
ADS048-48F(T/E)	48VDC 1.0A	None	CE	None / 300	

## AD1048F Series



**\*Convection Cooling**

Dimension:121(D)x40(W)x110(H)mm Package: 36pcs/ctn

48W Single Output

Input: 100~240VAC 47~63Hz

Model	Output	Redundant	Standard	MOQ	Datasheet
AD1040-05F	5VDC 8.0A	Option	CE	None	
AD1048-12F	12VDC 4.0A	Option	CE, UL	None	
AD1048-24F	24VDC 2.0A	Option	CE, UL	None	
AD1048-48F	48VDC 1.0A	Option	CE	None	

## AD1060F Series



**\*Convection Cooling**

Dimension:121(D)x40(W)x110(H)mm Package: 36pcs/ctn

60W Single Output

Input: 100~240VAC 47~63Hz

Model	Output	Redundant	Standard	MOQ	Datasheet
AD1060-24F	24VDC 2.5A	Option	CE	None	

## ADS060F(T/E) Series



T Version

E Version

**\*Convection Cooling**

Dimension:100(D)x36.5(W)x107(H)mm Package: 54pcs/ctn

60W Single Output

Input: 100~240VAC 47~63Hz

Model	Output	Redundant	Standard	MOQ(T/E)	Datasheet
ADS060-24F(T/E)	24VDC 2.5A	None	CE	None / 300	
ADS060-48F(T/E)	48VDC 1.25A	None	CE	None / 300	

**AD2060F Series****\*Convection Cooling**

Dimension:121(D)x40(W)x110(H)mm Package: 36pcs/ctn



60W Dual Output

Input: 100~240VAC 47~63Hz

Model	Output	Redundant	Standard	MOQ	Datasheet
AD20601F	5VDC±10% 4.0A 12VDC ----- 3.0A	None	CE	300	
AD20602F	5VDC±10% 2.0A 24VDC ----- 2.0A	None	CE	None	
AD20603F	12VDC±10% 2.0A 24VDC ----- 1.5A	None	CE	300	
AD20604F	10VDC±10% 2.0A 24VDC ----- 1.5A	None	CE	300	

**AD1072F Series****\*Convection Cooling**

Dimension:121(D)x56(W)x110(H)mm Package: 30pcs/ctn



72W Single Output

Input: 100~240VAC 47~63Hz

Model	Output	Redundant	Standard	MOQ	Datasheet
AD1072-12F	12VDC 6.0A	Option	CE, UL	None	
AD1072-24F	24VDC 3.0A	Option	CE, UL	None	
AD1072-48F	48VDC 1.5A	Option	CE	None	

**ADS072F(T/E) Series****\*Convection Cooling**

Dimension:100(D)x48.5(W)x107(H)mm Package: 45pcs/ctn



72W Single Output

Input: 100~240VAC 47~63Hz

Model	Output	Redundant	Standard	MOQ(T/E)	Datasheet
ADS072-12F(T/E)	12VDC 6.0A	None	CE	None / 300	
ADS072-24F(T/E)	24VDC 3.0A	None	CE	None / 300	
ADS072-48F(T/E)	48VDC 1.5A	None	CE	None / 300	

**AD1100F Series****\*Convection Cooling**

Dimension:121(D)x56(W)x110(H)mm Package: 30pcs/ctn



100W Single Output

Input: 100~240VAC 47~63Hz

Model	Output	Redundant	Standard	MOQ	Datasheet
AD1100-12F	12VDC 8.0A	Option	CE, UL	None	
AD1100-24F	24VDC 4.0A	Option	CE, UL	None	
AD1100-48F	48VDC 2.0A	Option	CE	None	

**ADS100F(T/E) Series****\*Convection Cooling**

Dimension:100(D)x48.5(W)x107(H)mm Package: 45pcs/ctn



100W Single Output

Input: 100~240VAC 47~63Hz

Model	Output	Redundant	Standard	MOQ(T/E)	Datasheet
ADS100-12F(T/E)	12VDC 8.0A	None	CE	None / 300	
ADS100-24F(T/E)	24VDC 4.0A	None	CE	None / 300	
ADS100-48F(T/E)	48VDC 2.0A	None	CE	None / 300	

**AD2100F Series****\*Convection Cooling**

Dimension:121(D)x56(W)x110(H)mm Package: 30pcs/ctn



100W Dual Output

Input: 100~240VAC 47~63Hz

Model	Output	Redundant	Standard	MOQ	Datasheet
AD21001F	12VDC±10% 7.0A 5VDC ----- 3.0A	None	CE	300	
AD21002F	24VDC±10% 3.5A 5VDC ----- 3.0A	None	CE	None	
AD21003F	24VDC±10% 3.0A 12VDC ----- 1.5A	None	CE	300	

**AD1120F Series****\*Convection Cooling**

Dimension:121(D)x75(W)x110(H)mm Package: 24pcs/ctn



120W Single Output

Input: 100~240VAC 47~63Hz

Model	Output	Redundant	Standard	MOQ	Datasheet
AD1120-12F	12VDC 10.0A	Option	CE, UL	None	
AD1120-24F	24VDC 5.0A	Option	CE, UL	None	
AD1120-48F	48VDC 2.5A	Option	CE, UL	None	

**ADS120F(T/E) Series****\*Convection Cooling**

Dimension:100(D)x57(W)x107(H)mm Package: 45pcs/ctn



T Version

E Version

120W Single Output

Input: 100~240VAC 47~63Hz

Model	Output	Redundant	Standard	MOQ(T/E)	Datasheet
ADS120-12F(T/E)	12VDC 10.0A	None	CE	None / 300	
ADS120-24F(T/E)	24VDC 5.0A	None	CE	None / 300	
ADS120-48F(T/E)	48VDC 2.5A	None	CE	None / 300	

**AD1150F Series****\*Convection Cooling**

Dimension:121(D)x75(W)x110(H)mm Package: 24pcs/ctn



150W Single Output

Input: 100~240VAC 47~63Hz

Model	Output	Redundant	Standard	MOQ	Datasheet
AD1150-12F	12VDC 12.5A	Option	CE, UL	None	
AD1150-24F	24VDC 6.3A	Option	CE, UL	None	
AD1150-48F	48VDC 3.2A	Option	CE, UL	None	

**ADS150F(T/E) Series****\*Convection Cooling**

Dimension:100(D)x57(W)x107(H)mm Package: 45pcs/ctn



T Version

E Version

150W Single Output

Input: 100~240VAC 47~63Hz

Model	Output	Redundant	Standard	MOQ(T/E)	Datasheet
ADS150-24F(T/E)	24VDC 6.3A	None	CE	None / 300	
ADS150-48F(T/E)	48VDC 3.2A	None	CE	None / 300	

**AD2150F Series****\*Convection Cooling**

Dimension:121(D)x75(W)x110(H)mm Package: 24pcs/ctn



150W Dual Output

Input: 100~240VAC 47~63Hz

Model	Output	Redundant	Standard	MOQ	Datasheet
AD21501F	12VDC±10% 11.0A 5VDC ----- 3.0A	None	CE	300	
AD21502F	24VDC±10% 5.5A 5VDC ----- 3.0A	None	CE	None	

**AD1240S Series****\*Built-in cooling fan**

Dimension:121(D)x75(W)x110(H)mm Package: 24pcs/ctn



240W Single Output

Input: 100~240VAC 47~63Hz

Model	Output	Redundant	Standard	MOQ	Datasheet
AD1240-12S	12VDC 20.0A	Option	CE, UL	None	
AD1240-24S	24VDC 10.0A	Option	CE, UL	None	
AD1240-48S	48VDC 5.0A	Option	CE, UL	None	

**AD1240C Series****\*Convection Cooling**

Dimension:121(D)x100(W)x110(H)mm Package: 12pcs/ctn



240W Single Output

Input: 100~240VAC 47~63Hz Active PFC

Model	Output	Redundant	Standard	MOQ	Datasheet
AD1240-12C	12VDC 20.0A	Option	CE, UL	200	
AD1240-24C	24VDC 10.0A	Option	CE, UL	None	
AD1240-48C	48VDC 5.0A	Option	CE, UL	200	



**ADS240S Series****\*Convection Cooling**

Dimension:100(D)x100(W)x107(H)mm Package: 27pcs/ctn



240W Single Output

Input: 115/230VAC 47~63Hz

Model	Output	Redundant	Standard	MOQ(T/E)	Datasheet
ADS240-12S(T/E)	12VDC 20.0A	None	CE	None / 200	
ADS240-24S(T/E)	24VDC 10.0A	None	CE	None / 200	
ADS240-48S(T/E)	48VDC 5.0A	None	CE	None / 200	

**AD1240SC Series****\*Convection Cooling**

Dimension:121(D)x100(W)x110(H)mm Package: 24pcs/ctn



240W Single Output

Input: 115/230VAC 47~63Hz

Model	Output	Redundant	Standard	MOQ	Datasheet
AD1240-24SC	24VDC 10.0A	None	CE, UL	None	
AD1240-48SC	48VDC 5.0A	None	CE, UL	None	

**AD2240S Series****\*Built-in cooling fan**

Dimension:121(D)x75(W)x110(H)mm Package: 24pcs/ctn



240W Dual Output

Input: 115/230VAC 47~63Hz

Model	Output	Redundant	Standard	MOQ	Datasheet
AD22402S	24VDC±10% 9.0A 5VDC ----- 3.0A	None	CE	None	
AD22403S	48VDC±10% 4.5A 5VDC ----- 3.0A	None	CE	200	

**AD2240C Series****\*Convection Cooling**

Dimension:121(D)x100(W)x110(H)mm Package: 12pcs/ctn



240W Dual Output

Input: 100~240VAC 47~63Hz Active PFC

Model	Output	Redundant	Standard	MOQ	Datasheet
AD22401C	12VDC±10% 18.0A 5VDC ----- 3.0A	None	CE	200	
AD22402C	24VDC±10% 9.0A 5VDC ----- 3.0A	None	CE, UL	200	
AD22403C	48VDC±10% 4.5A 5VDC ----- 3.0A	None	CE	200	

**AD1360S Series****\*Built-in cooling fan**

Dimension:121(D)x75(W)x110(H)mm Package: 24pcs/ctn



360W Single Output

Input: 115/230VAC 47~63Hz

Model	Output	Redundant	Standard	MOQ	Datasheet
AD1360-24S	24VDC 15.0A	Option	CE, UL	None	
AD1360-48S	48VDC 7.5A	Option	CE	None	

**ADS360S Series****\*Convection Cooling**

Dimension:100(D)x120(W)x107(H)mm Package: 18pcs/ctn



360W Single Output

Input: 115/230VAC 47~63Hz

Model	Output	Redundant	Standard	MOQ(T/E)	Datasheet
ADS360-24S(T/E)	24VDC 15.0A	None	CE	None / 200	
ADS360-48S(T/E)	48VDC 7.5A	None	CE	None / 200	

**AD1360C Series****\*Built-in cooling fan**

Dimension:121(D)x100(W)x110(H)mm Package: 12pcs/ctn



360W Single Output

Input: 100~240VAC 47~63Hz Active PFC

Model	Output	Redundant	Standard	MOQ	Datasheet
AD1360-12C	12VDC 30.0A	Option	CE, UL	200	
AD1360-24C	24VDC 15.0A	Option	CE, UL	None	
AD1360-48C	48VDC 7.5A	Option	CE, UL	200	

## AD2360C Series

\*Built-in cooling fan

Dimension:121(D)x100(W)x110(H)mm Package: 12pcs/ctn



360W Dual Output

Input: 100~240VAC 120~370VDC 47~63Hz Active PFC

Model	Output	Redundant	Standard	MOQ	Datasheet
AD23601C	12VDC±10% 28.0A 5VDC ----- 3.0A	None	CE	200	
AD23602C	24VDC±10% 14.0A 5VDC ----- 3.0A	None	CE, UL	200	
AD23603C	48VDC±10% 7.0A 5VDC ----- 3.0A	None	CE	200	

## AD1500S Series

\*Built-in temperature controlled fan

Dimension:121(D)x100(W)x110(H)mm Package: 12pcs/ctn



500W Single Output

Input: 115/230VAC 47~63Hz

Model	Output	Redundant	Standard	MOQ	Datasheet
AD1500-24S	24VDC 21.0A	Option	CE	None	
AD1500-48S	48VDC 10.5A	Option	CE	None	

## AD2500S Series

\*Built-in temperature controlled fan

Dimension:121(D)x100(W)x110(H)mm Package: 12pcs/ctn



500W Dual Output

Input: 115/230VAC 47~63Hz

Model	Output	Redundant	Standard	MOQ	Datasheet
AD25002S	24VDC±10% 20.0A 5VDC ----- 3.0A	None	CE	None	
AD25003S	48VDC±10% 10.0A 5VDC ----- 3.0A	None	CE	200	

## ADS500S Series

\*Convection Cooling

Dimension:100(D)x130(W)x107(H)mm Package: 18pcs/ctn



500W Single Output

Input: 115/230VAC 47~63Hz

Model	Output	Redundant	Standard	MOQ(T/E)	Datasheet
ADS500-24S(T/E)	24VDC 21.0A	None	CE	None / 200	
ADS500-48S(T/E)	48VDC 10.5A	None	CE	None / 200	

## ADS750S Series

\*Built-in temperature controlled fan

Dimension:110(D)x141.5(W)x110(H)mm Package: 18pcs/ctn



750W Single Output

Input: 115/230VAC 47~63Hz

Model	Output	Redundant	Standard	MOQ(T/E)	Datasheet
ADS750-24S(T/E)	24VDC 31.0A	None	CE	None / 200	
ADS750-48S(T/E)	48VDC 15.5A	None	CE	None / 200	

## Terminal allocation

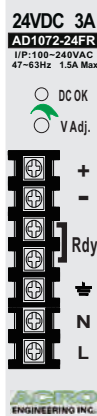

### Designation

### Description

DC OK

Green LED Indicator

V Adj.

O/P Voltage adjustment

+

Output Positive

-

Output Negative

Rdy

DC OK signal(Short)

⏏

Earth

N

Input Neutral

L

Input Line

# DC Motor Power Supply

## AD1100MF Series

\*Convection Cooling

Dimension:121(D)x56(W)x110(H)mm Package: 30pcs/ctn



100W Single Output

Input: 100~240VAC 47~63Hz

Model	Output	Loading		Redundant	Standard	MOQ	Datasheet
		Rated	Peak				
AD1100M-24F	24VDC±10%	4.0A	8.0A	Yes	CE	300	
AD1100M-48F	48VDC±10%	2.0A	4.0A	Yes	CE	300	
AD1100M-72F	72VDC±10%	1.4A	2.8A	Yes	CE	300	

## AD2100MF Series

\*Convection Cooling

Dimension:121(D)x56(W)x110(H)mm Package: 30pcs/ctn



100W Dual Output

Input: 100~240VAC 47~63Hz

Model	Output	Loading		Redundant	Standard	MOQ	Datasheet
		Rated	Peak				
AD2100M2F	24VDC±10%	3.5A	7.0A	Yes	CE	300	
	5VDC -----	3.0A	5.0A				
AD2100M3F	48VDC±10%	1.8A	3.6A	Yes	CE	300	
	5VDC -----	3.0A	5.0A				

## AD1150MF Series

\*Convection Cooling

Dimension:121(D)x75(W)x110(H)mm Package: 24pcs/ctn



150W Single Output

Input: 100~240VAC 47~63Hz

Model	Output	Loading		Redundant	Standard	MOQ	Datasheet
		Rated	Peak				
AD1150M-24F	24VDC±10%	6.3A	10.0A	Yes	CE	300	
AD1150M-48F	48VDC±10%	3.2A	5.0A	Yes	CE	300	
AD1150M-72F	72VDC±10%	2.0A	3.5A	Yes	CE	300	

## AD2150MF Series

\*Convection Cooling

Dimension:121(D)x75(W)x110(H)mm Package: 24pcs/ctn



150W Dual Output

Input: 100~240VAC 47~63Hz

Model	Output	Loading		Redundant	Standard	MOQ	Datasheet
		Rated	Peak				
AD2150M2F	24VDC±10%	5.5A	11.0A	Yes	CE	300	
	5VDC -----	3.0A	5.0A				
AD2150M3F	48VDC±10%	3.0A	6.0A	Yes	CE	300	
	5VDC -----	3.0A	5.0A				

## AD1240MS Series

\*Built-in cooling fan

Dimension:121(D)x75(W)x110(H)mm Package: 24pcs/ctn



240W Single Output

Input: 115/230VAC 47~63Hz

Model	Output	Loading		Redundant	Standard	MOQ	Datasheet
		Rated	Peak				
AD1240M-24S	24VDC±10%	10.0A	16.0A	Yes	CE	200	
AD1240M-48S	48VDC±10%	5.0A	8.0A	Yes	CE	200	
AD1240M-72S	72VDC±10%	3.5A	5.0A	Yes	CE	200	

## AD2240MS Series

\*Built-in cooling fan

Dimension:121(D)x75(W)x110(H)mm Package: 24pcs/ctn



240W Dual Output

Input: 115/230VAC 47~63Hz

Model	Output	Loading		Redundant	Standard	MOQ	Datasheet
		Rated	Peak				
AD2240M2S	24VDC±10%	9.0A	14.4A	Yes	CE	200	
	5VDC -----	3.0A	5.0A				
AD2240M3S	48VDC±10%	4.5A	7.2A	Yes	CE	200	
	5VDC -----	3.0A	5.0A				

## AD1500MS Series

\*Built-in temperature controlled fan

Dimension:121(D)x100(W)x110(H)mm Package: 12pcs/ctn



500W Single Output

Input: 115/230VAC 47~63Hz

Model	Output	Loading		Redundant	Standard	MOQ	Datasheet
		Rated	Peak				
AD1500M-24S	24VDC±10%	21.0A	30.0A	Yes	CE	200	
AD1500M-48S	48VDC±10%	10.5A	16.0A	Yes	CE	200	
AD1500M-72S	72VDC±10%	7.0A	10.5A	Yes	CE	200	



## Lead -Acid Battery Charger

### AD1072CF(R) Series

\*Convection Cooling

Dimension:121(D)x56(W)x110(H)mm Package: 30pcs/ctn



3-Stage Charging Control

72W Single Output

Input: 100~240VAC 47~63Hz Full Range

Model	Charging Voltage Boost	Charging Voltage Float	Charging Current	Alarm	Standard	MOQ	Datasheet
AD1072C-12F(R)	+14.7VDC	+13.8VDC	6.0A Max.	Option	CE	300	
AD1072C-24F(R)	+29.4VDC	+27.6VDC	3.0A Max.	Option	CE	300	
AD1072C-36F(R)	+44.1VDC	+40.8VDC	2.0A Max.	Option	CE	300	
AD1072C-48F(R)	+58.8VDC	+55.2VDC	1.5A Max.	Option	CE	300	

### AD1120CF(R) Series

\*Convection Cooling

Dimension:121(D)x75(W)x110(H)mm Package: 24pcs/ctn



3-Stage Charging Control

120W Single Output

Input: 100~240VAC 47~63Hz Full Range

Model	Charging Voltage Boost	Charging Voltage Float	Charging Current	Alarm	Standard	MOQ	Datasheet
AD1120C-12F(R)	+14.7VDC	+13.8VDC	8.0A Max.	Option	CE	300	
AD1120C-24F(R)	+29.4VDC	+27.6VDC	4.0A Max.	Option	CE	300	
AD1120C-36F(R)	+44.1VDC	+40.8VDC	2.5A Max.	Option	CE	300	
AD1120C-48F(R)	+58.8VDC	+55.2VDC	2.0A Max.	Option	CE	300	

## Back-up Power Supply

### AD2060CF Series

\*Convection Cooling

Dimension:121(D)x40(W)x110(H)mm Package: 36pcs/ctn



60W Dual Output

Input: 100~240VAC 47~63Hz

Model	Output		Redundant	Standard	MOQ	Datasheet
AD2060C1F	13.8VDC±10%	2.5A	None	CE	300	
	13.8VDC -----	1.5A				
AD2060C2F	27.6VDC±10%	1.5A	None	CE	300	
	27.6VDC -----	0.5A				

### AD2100CF Series

\*Convection Cooling

Dimension:121(D)x56(W)x110(H)mm Package: 30pcs/ctn



100W Dual Output

Input: 100~240VAC 47~63Hz

Model	Output		Redundant	Standard	MOQ	Datasheet
AD2100C1F	13.8VDC±10%	5.5A	None	CE	300	
	13.8VDC -----	1.5A				
AD2100C2F	27.6VDC±10%	3.0A	None	CE	300	
	27.6VDC -----	0.5A				

### AD2120CF Series

\*Convection Cooling

Dimension:121(D)x75(W)x110(H)mm Package: 24pcs/ctn



120W Dual Output

Input: 100~240VAC 47~63Hz

Model	Output		Redundant	Standard	MOQ	Datasheet
AD2120C1F	13.8VDC±10%	7.0A	None	CE	300	
	13.8VDC -----	1.5A				
AD2120C2F	27.6VDC±10%	4.0A	None	CE	300	
	27.6VDC -----	1.5A				

## ODM Service

ACRO Engineering Inc. has more than 10 years' experience, capability, and R&D resources to make any ODM integration a glowing success! We are a professional manufacturer to make your idea and concept come to viable. Our customized products have been successful applied in many industrial fields.

We have been handling diverse customer designing project and are satisfied with customers. Before the project begins, we will discuss the detailed specifications and concepts with customer. To meet their requirements, the total cost for design, prototyping, and estimated cost per unit will be notified. The good service is provided indeed. If you have any special inquiry, please contact us and we promise to offer you the best solution to power up your subject.

### LED Application

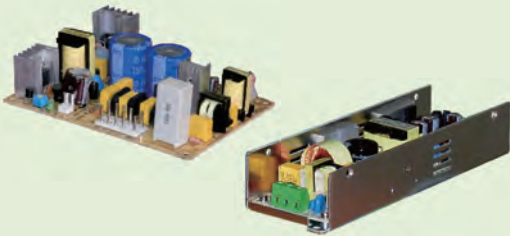

### Electric Screwdriver Application



### Back-up Power Supply



### Battery Charger

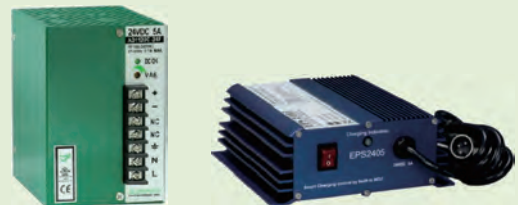

## Installation Instruction

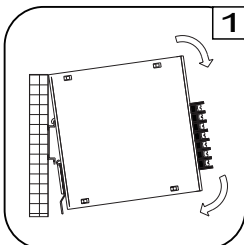

Place the top of the Power Supply over the top of the DIN rail. Tilt the bottom of the power supply toward the DIN rail until it snaps into place.

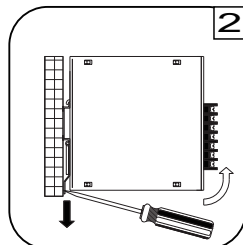

To remove the power supply from the DIN rail, use a flathead screwdriver to pull down the bottom of the rail mounting plate and tilt it away from the DIN rail.

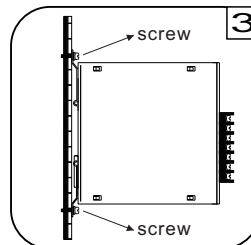

To install the power on the wall or other plate, loosening screws on mounting bracket and pull both brackets out first. Then re-screwing the two brackets with screws onto wall/plate.

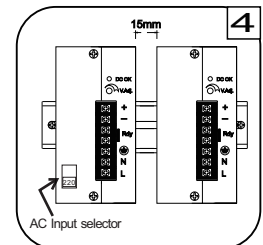

The left housing of the power supply is designed as a heat sink. Please keeping a minimum distance of 15mm from each other.